

# **SPLIT TYPE AIR CONDITIONER INSTRUCTION MANUAL**



This instruction manual contains important information and recommendations that we would ask you to comply with to obtain best results from air conditioner.

Thank you once again.

# CONTENTS

---

SAFETY PRECAUTIONS .....	1
NAMES OF PARTS .....	4
INDOOR UNIT DISPLAY .....	5
EMERGENCY FUNCTION & AUTO-RESTART FUNCTION .....	6
REMOTE CONTROLLER .....	7
OPERATING INSTRUCTIONS .....	11
INSTALLATION MANUAL.....	20
MAINTENANCE .....	35
TROUBLESHOOTING .....	36

In line with the company's policy of continual product improvement, the aesthetic and dimensional characteristics, technical data and accessories of this appliance may be changed without notice.

## SAFETY RULES AND RECOMMENDATIONS FOR THE INSTALLER

 The ratings of the fuse installed in the built in control unit are 4A / 250V .

 The appliance must be fitted with means for disconnection from the supply mains having a contact separation in all poles that provide full disconnection under overvoltage category III conditions, and these means must be incorporated in the fixed wiring in accordance with the wiring rules.

 Only use the air conditioner as instructed in this booklet.

 The appliance must be installed in accordance with applicable national regulations.

 Before accessing the terminals , all the power circuits must be disconnected from the power supply.

 The appliance shall be installed in accordance with national wiring regulations.

## SAFETY RULES AND RECOMMENDATIONS FOR THE USER

 **C**leaning and maintenance must be carried out by specialized technical personnel. In any case disconnect the appliance from the mains electricity supply before carrying out any cleaning or maintenance.

 **T**his appliance has been made for air conditioning domestic environments and must not be used for any other purpose.

 **T**he batteries in remote controller must be recycled or disposed of properly.

 **I**f the appliance gives off smoke or there is a smell of burning, immediately cut off the power supply and contact the Service Centre.

 **H**ave repairs carried out only by an authorised Service Centre of the manufacturer. Incorrect repair could expose the user to the risk of electric shock, etc.

 **U**nhook the automatic switch if you foresee not to use the device for a long time. The airflow direction must be properly adjusted

## SAFETY RULES AND PROHIBITIONS

⊖ Do not obstruct the air inlet or outlet of the indoor or the outdoor unit.  
The obstruction of these openings causes a reduction in the operative efficiency of the conditioner with possible consequent failures or damages.

⊖ This appliance is not intended for use by persons (including children ) with reduced physical, sensory or mental capabilities, or lack of experience and knowledge, unless they have been given supervision or instruction concerning use of the appliance by a person responsible for their safety.

⊖ Children should be supervised to ensure that they do not play with the appliance. If the supply cord is damaged, it must be replaced by the manufacturer, its service agent or similarly qualified persons in order to avoid a hazard.

# NAMES OF PARTS

## Indoor unit

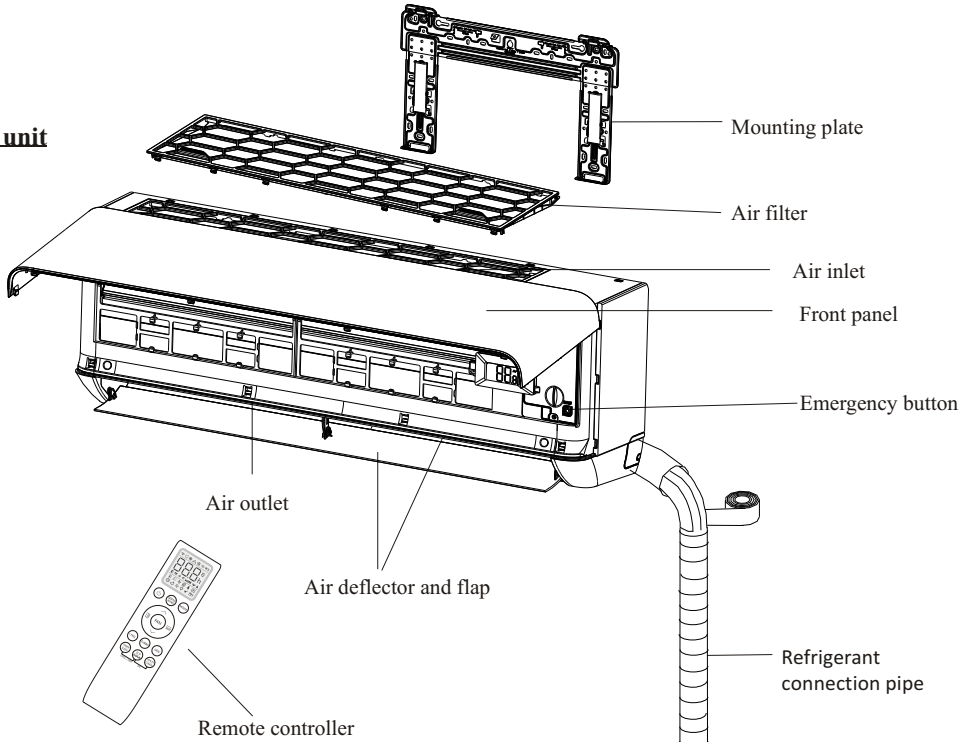

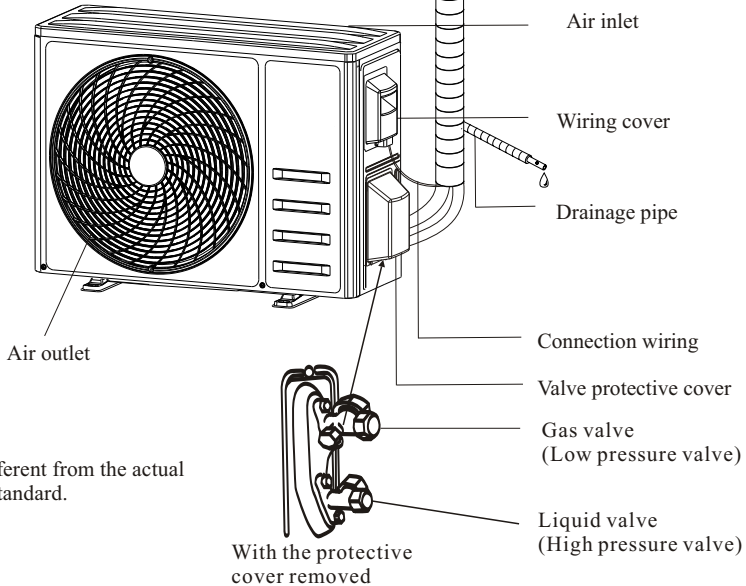

## Outdoor unit



**Note:** This figure shown may be different from the actual object. Please take the latter as the standard.

# INDOOR UNIT DISPLAY



No.	Led		Function
1	SLEEP		SLEEP mode
2	Temperature display (if present) /Error code		(1) Lights up during Timer operation when the air conditioner is operational (2) Displays the malfunction code when fault occurs.
3	TIMER		Lights up during Timer operation.

 *The shape and position of switches and indicators may be different according to the model, but their function is the same.*

# EMERGENCY FUNCTION & AUTO-RESTART FUNCTION

## EMERGENCY FUNCTION

If the remote controller fails to work or maintenance necessary, proceed as following:

Open and lift the front panel up to an angle to reach the emergency button.

For heating model, press the emergency button first and the unit will operate in COOL mode. Press for a second time within 3 seconds, and unit will operate in HEAT mode. Press for third after 5 seconds, the unit will turn off.

For cooling only models, press the emergency button once, and the unit will operate in COOL mode. Press again, the unit will turn off.

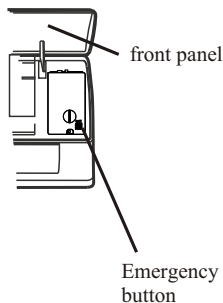

The emergency button is located on E-box cover of the unit under the front panel.

## AUTO-RESTART FUNCTION

The appliance is preset with an auto-restart function. In case of a sudden power failure, the module will memorizes the setting conditions before the power failure. When the power restores, the unit will restart automatically with the previous settings preserved by the memory function.

 *The shape and position of the emergency button may be different according to the model, but their function is the same.*



# REMOTE CONTROLLER

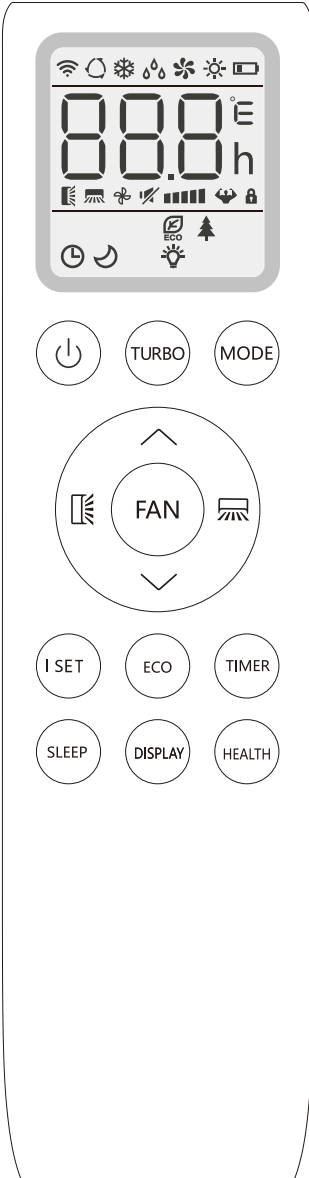



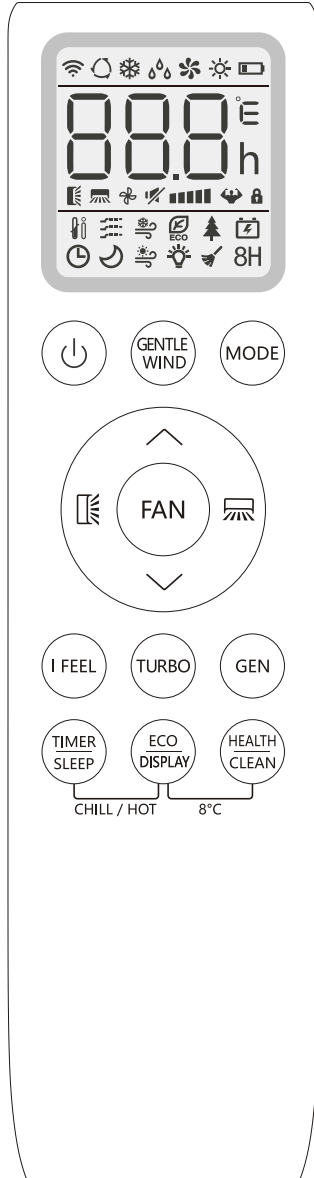







For ON/OFF models





For inverter models

# REMOTE CONTROLLER

## Remote controller buttons

No.	Buttons	Function
1		To turn on/off the air conditioner
2	GENTLE WIND	To activate the function of Gentle wind.
3	MODE	To select the operation mode: AUTO, COOL, DRY, FAN, HEAT.
4	 (TEMP UP)	To increase the setting temperature, lengthen the time in TIMER setting.
5	 (TEMP DN)	To decrease the setting temperature, reduce the time in TIMER setting.
6		To adjust the air flow direction vertically(optional).
7		To adjust the air flow direction horizontally.
8	FAN	To adjust the fan speed: auto, mute, low, mid-low, mid, mid-high, high. Turbo
9	I FEEL	To activate the function of I FEEL
10	I SET	To activate the function of I SET
11	TURBO	To switch on/off the TURBO mode
12	GEN	To switch on/off the GENERATOR mode
13	TIMER/SLEEP	To switch on/off the TIMER function and SLEEP mode
14	ECO/DISPLAY	To switch on/off the ECO mode and LED display light
15	HEALTH/CLEAN	To switch on/off the HEALTH function and Auto Clean function..
16	TIMER/SLEEP + ECO/DISPLAY	To switch on/off the CHILL WIND and HOT WIND function.
17	ECO/DISPLAY + HEALTH/CLEAN	To switch on/off the CHILL WIND and HOT WIND function.
18	 (  +  )	To activate the function of Child Lock, press  and  buttons together for more than 3 seconds.

 The display and some functions of the remote control may vary according to the model.

 The shape and position of buttons and indicators may vary according to the model, but their function is the same.

 The unit confirms the correct reception of each button with a beep.

 Certain functions may not be available for your air conditioner.

 The batteries in remote controller must be recycled or disposed of properly.

# REMOTE CONTROLLER

## Remote controller DISPLAY, meaning of symbols on the liquid crystal display

No.	Symbols	Meaning
1		AUTO MODE indicator
2		COOLING MODE indicator
3		DRY MODE indicator
4		FAN MODE indicator
5		HEATING MODE indicator
6		BATTERY indicator
7		TEMPERATURE/ CLOCK indicator
8		FLAP SWING (Air flow) indicator
9		MUTE indicator
10		FAN SPEED indicator
11		AUTO FAN indicator
12		TURBO indicator
13		CHILD LOCK indicator
14		I FEEL indicator
15		GENTLE WIND indicator
16		CHILL WIND indicator
17		ECO indicator
18		HEALTHY indicator
19		GENERATOR MODE indicator
20		TIMER indicator
21		SLEEP MODE indicator
22		HOT WIND indicator
23		DISPLAY LIGHT indicator
24		CLEAN function indicator
25		8° C heating function indicator

# REMOTE CONTROLLER

## Replacement of Batteries

Remove the battery cover plate from the rear of the remote controller, by sliding it in the direction of the arrow.

Install the batteries according the direction (+and -)shown on the Remote Controller.

Reinstall the battery cover by sliding it into place.

⚠ Use 2 LRO 3 AAA (1.5V) batteries . Do not use rechargeable batteries . Replace the old batteries with new ones of the same type when the display is no longer legible.

Do not dispose batteries as unsorted municipal waste. Collection of such waste separately for special treatment is necessary.

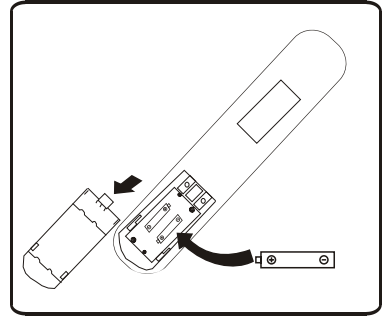

Recommendations for locating and using the remote controller holder (if present).

The remote controller be kept in a wall-mounted holder.

# OPERATING INSTRUCTIONS

The air sucked by the fan enters from the grill and passes through the filter, then it is cooled/dehumidified or heated through the heat exchanger.

The direction of the air outlet is motorized up and down by flaps, and manually moved right and left by the vertical deflectors, for some models, the vertical deflectors could be controlled by motor as well.

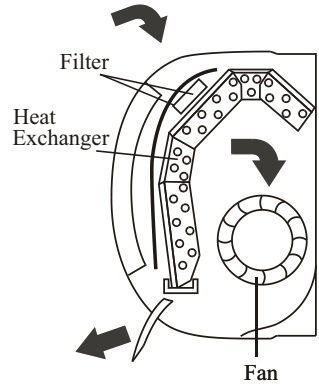

## Turn ON /Turn OFF the air conditioner

Press the button  to turn on or turn off the air conditioner.

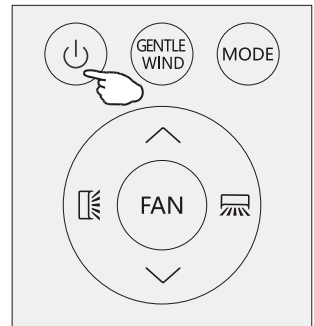



## COOLING MODE



The cooling function allows the air conditioner to cool the room and at the same time reduces Air humidity.

To activate the cooling function ( COOL ) , press the **MODE** button until the symbol  appears on the display.

With the button  or  set a temperature lower than that of the room.

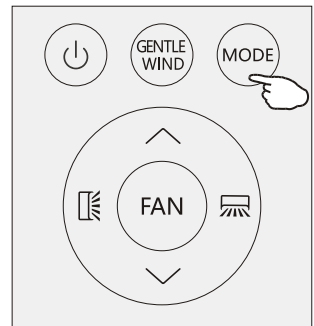

# OPERATING INSTRUCTIONS

## HEATING MODE



The heating function allows the air conditioner to heat the room.

To activate the heating function ( HEAT ), press the MODE button until the symbol ☀ appears on the display.

With the button ▼ or ▲ set a temperature higher than that of the room.



In HEATING operation, the appliance can automatically activate a defrost cycle, which is essential to clean the frost on the condenser so as to recover its heat exchange function. This procedure usually lasts for 2-10 minutes. During defrosting, indoor unit fan stop operation. After defrosting, it resumes to HEATING mode automatically.

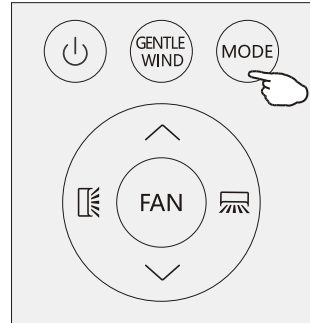

## DRY MODE



This function reduces the humidity of the air to make the room more comfortable.

To set the DRY mode, Press MODE until ☁ appears in the display. An automatic function of pre-setting is activated.

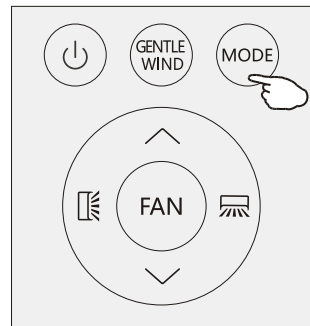

## FAN MODE(Not FAN button)



Fan mode, air ventilation only.

To set the FAN mode, press MODE until ☪ appears on the display.

## AUTO MODE



Automatic mode.

To set the AUTO mode, press MODE until ↻ appears on the display.

In AUTO mode the run mode will be set automatically according to the room temperature.

# OPERATING INSTRUCTIONS

## Change the fan speed



Press **FAN** button to set the running fan speed, it can be set to AUTO/ MUTE/ LOW/ MID-LOW/ MID/ MID-HI/ HIGH/TURBO speed.

Flashing



## AIR FLOW CONTROL

1. Normal 4 way air flow (vertical and horizontal):

- (1) Press  to activate the horizontal flaps to swing from up to down. Press again to stop the swing movement at the current angle.
- (2) Press  to activate the vertical deflectors to swing from left to right. Press again to stop the swing movement at the current angle.

2. Vector precise air flow

- (1) Press  and hold for 1s, it will go into the horizontal vector air flow, you can select a small swing angle you want:

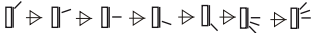

Stop selection for 5s, press  again, exit the horizontal vector precise air flow.

- (2) Press  and hold for 1s, it will go into the vertical vector air flow:



Stop selection for 5s, press  again, exit the vertical vector precise air flow.

3. If the vertical deflectors are positioned manually which placed under the flaps, they are allowed to move the air flow direct to rightward or leftward.

- ⚠ *This adjustment must be done while the appliance is switched off.*
- ⚠ *Never position "Flaps" manually, the delicate mech-anism might seriously damaged!*
- ⚠ *Never poke fingers, sticks or other objects in the air inlet or outlet vents. Such accidental contact with liveparts might cause unforeseeable damage or injury.*

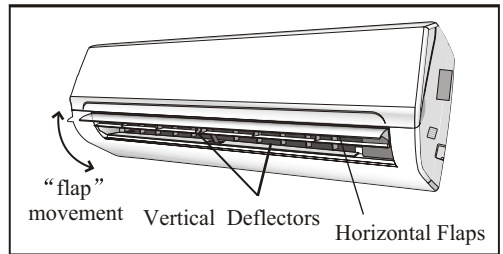
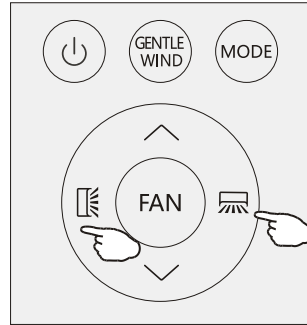
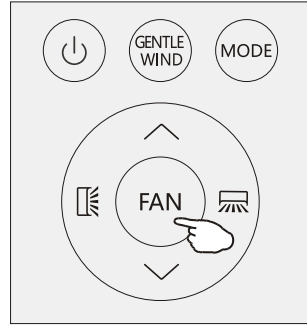

# OPERATING INSTRUCTIONS

## GENTLE WIND (Optional)



In this mode the appliance will close its vertical louvers, the air flow through the holes of louvers, the room is cool but no winds.

Press the GENTLE WIND button shortly, the  appears on the display, and the appliance will run in GENTLE WIND mode. Press again to cancel it..

### NOTE:

The gentle wind function is available in COOLING mode only.

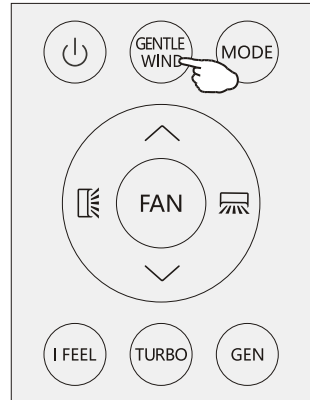

## I FEEL function

### I FEEL

Press **I FEEL** button to activate the function, the  will appear on the remote display. Do it again to deactivate this function.

This function enables the remote control to measure the temperature at its current location, and send this signal to the air conditioner to optimize the temperature around you and ensure the comfort. It will automatically deactivate 2 hours later.

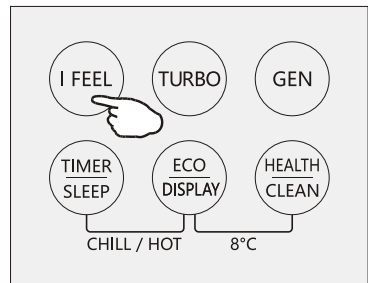

## Turbo function



To activate turbo function, press the TURBO button, and  will appear on the display. Press again to cancel this function.

In COOL/HEAT mode, when you select TURBO feature, the appliance will operate the fast cooling/fast heating with the highest fan speed.

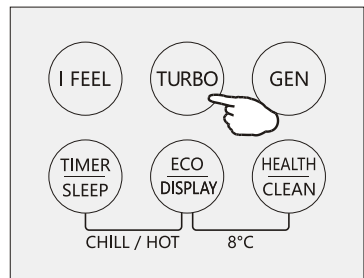



# OPERATING INSTRUCTIONS

## GENERATOR MODE (Optional)



The air conditioner works in generator mode, it is helpful for the unstable net power area.

Through GEN mode, you can choose the current level of the unit. There are three levels (L1, L2, L3) in this mode, and the current increases in turn.

To activate GEN function, pressing the button GEN and the unit current level will cycle as below  
OFF → L3 → L2 → L1 ”

Running current (% of rated current):

L1: 30%, L2: 50%, L3: 70%

To cancel this function, press the GEN until code OF appears on the display.

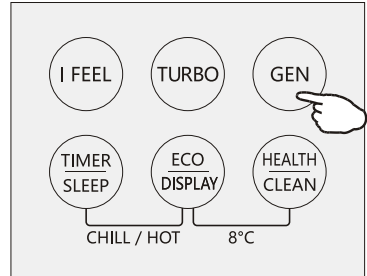

## SLEEP MODE



Pre-setting automatic operating program.

Press SLEEP button and hold for 2s to activate the sleep mode, and ☾★ appears on the display. Press and hold for 2s again to cancel this mode.

In sleep mode, the air conditioner will automatically adjust the temperature and fan speed to make the room more comfortable during the night.

After 10 hours running in sleep mode, the air conditioner will change to the previous setting mode.

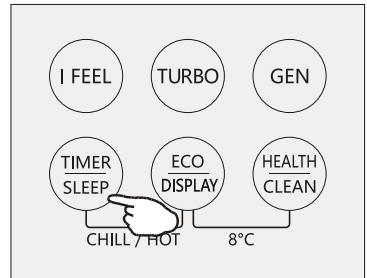

## ECO MODE



In this mode the appliance automatically sets the operation to save energy.

Press the ECO button, the  appears on the display, and the appliance will run in ECO mode. Press again to cancel it.

### NOTE:

The ECO function is available in both COOLING and HEATING modes.

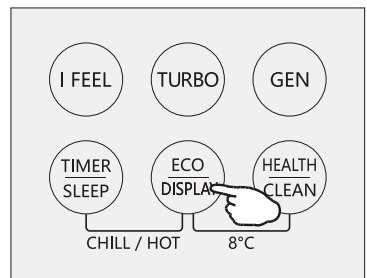

# OPERATING INSTRUCTIONS

## LED display light ON/OFF

Press **DISPLAY** button and hold for 2s to turn on/off the indoor LED display light.

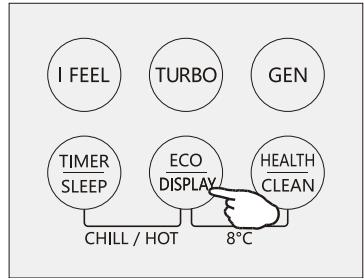

## HEALTH function (Optional)

Press **HEALTH** button to active / exit the health functions such as ion generator/ plasma etc

Note: Health function is not available when the air conditioner is off.

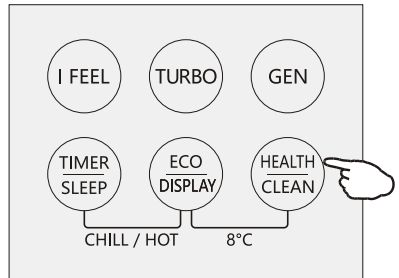

## SELF-CLEAN function (Optional)

1. This function help carry away the accumulated dirt, bacteria, etc from the evaporator
2. Turn off the air conditioner, press "CLEAN" button to enter this function and it will show "CL" on the display of indoor unit.
3. This function will run about 30 minutes, and it will exit automatically. You will hear 2 beeps when it's finished or cancelled.
4. It's normal if there are some noise during this function process, as plastic materials expand with heat and contract with cold.
5. We suggest operate this function as the following ambient condition to avoid certain safety protection features.

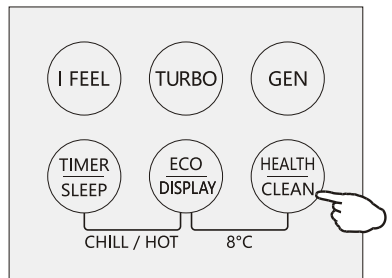

Indoor unit	Temp<30°C
Outdoor unit	5°C<Temp<30°C

6. We suggest operate this function once every 3 months.

# OPERATING INSTRUCTIONS

## TIMER MODE----SET TIMER OFF



To set the air conditioner switching-off automatically.

With the AC on, press the Timer button and then use the  $\wedge$  and  $\vee$  buttons to set the length of time before the AC will turn off. Press the timer button again to start the countdown.

Note: To cancel the set function, press the TIMER button again.

Note: In case of power off, it is necessary to set TIMER OFF again

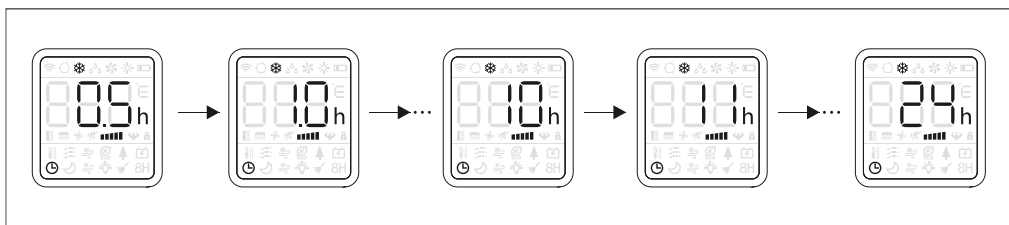
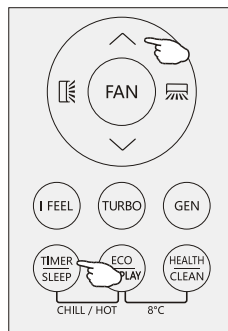

## TIMER MODE----SET TIMER ON



To set the air conditioner switching-on automatically.

With the AC off, press the Timer button and use the  $\wedge$  and  $\vee$  buttons to set the desired amount of time before the AC turns on. Press the timer button again to start the countdown.

When the timer setting was done, you can set the operation mode, fan speed, desired temperature, air flow when air conditioner star to run.

Note: To cancel the timer function, press the TIMER button again.

Note: In case of power off, it is necessary to set TIMER ON again

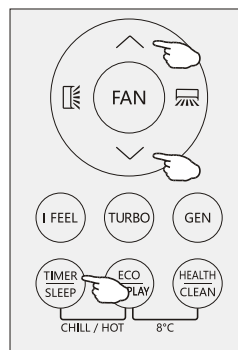

# OPERATING INSTRUCTIONS

## CHILL wind/ HOT wind function (Optional)



1. In cooling mode, press both TIMER/SLEEP and ECO/DISPLAY buttons and hold for 2s to activate the chill wind function.
2. In heating mode, press both TIMER/SLEEP and ECO/DISPLAY buttons and hold for 2s to activate the hot wind function.
3. Press both TIMER/SLEEP and ECO/DISPLAY buttons and hold for 2s to exit the chill wind or hot wind function.

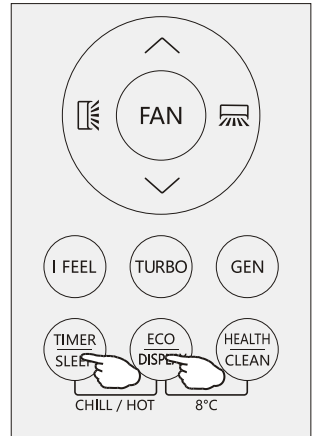

## 8°C heating function (Optional)



1. Press both ECO/DISPLAY and HEALTH/CLEAN buttons and hold for 2s to activate the 8°C heating.
2. If the air conditioner is standby, this function enable the air conditioner automatically start heating when the indoor temperature is equal or lower than 8°C, it will return standby if the temperature is equal or higher than 18°C.
3. When the AC was turn off, press both ECO/DISPLAY and HEALTH/CLEAN buttons and hold for 2s to exit the 8°C heating.

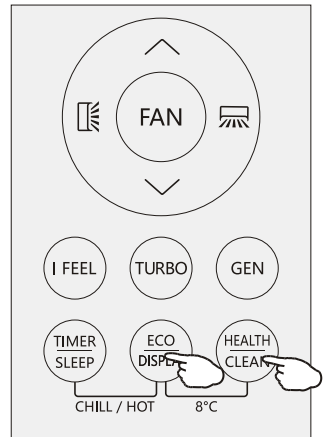

## I SET function(Optional)

In each mode of COOLING/HEATING/FAN/DRY, adjust the temperature(COOLING/HEATING), fan speed (COOLING/HEATING/FAN)and swing as your favourite, then keep pressing "I SET" button over 3 seconds until "AU" appears on the display and the background of display change to lighting, the remote controller will run and remember these settings. You can reset it by repeat the above operation.

In each mode of COOLING/HEATING/FAN/DRY, press "I SET" button to activate this function, the AC will run as your favourite setting and you will see AU flashing on the remote controller. Press it again or other buttons to cancel this function.



# OPERATING INSTRUCTIONS

## Operating Temperature

The air conditioner is programmed for comfortable and suitable living conditions as below if used outside the conditions, certain safety protection features might come into effect.,

Fix air conditioner:

<b>MODE</b> <b>Temperature</b>	<b>Cooling operating</b>	<b>Heating operating</b>	<b>Drying operating</b>
<b>Room temperature</b>	17°C~32°C	0°C~27°C	17°C~32°C
<b>Outdoor temperature</b>	15°C~43°C For T1 Climate	-7°C~24°C	15°C~43°C For T1 Climate
	15°C~52°C For T3 Climate		15°C~52°C For T3 Climate

Inverter air conditioner:

<b>MODE</b> <b>Temperature</b>	<b>Cooling operating</b>	<b>Heating operating</b>	<b>Drying operating</b>
<b>Room temperature</b>	17°C~32°C	0°C~30°C	17°C~32°C
<b>Outdoor temperature</b>	15°C~53°C	-20°C~30°C	15°C~53°C
	-15°C~53°C For models with low temperature cooling system		-15°C~53°C For models with low temperature cooling system

 *The unit does not operate immediately if it is turned on after being turned off or after changing the mode during operation. This is a normal self-protection action, you need to wait for about 3 minutes.*

 *The capacity and efficiency are according to the test conducted at full-load operation (The highest speed of indoor fan motor and the maximum open angle of the flaps and deflectors are requested.)*

## ■ Important Considerations

- The air conditioner you buy must be installed by professional personnel and the “Installation manual” is used only for the professional installation personnel! The installation specifications should be subject to our after-sale service regulations.
- When filling the combustibile refrigerant, any of your rude operations may cause serious injury or injuries to human body or bodies and object or objects.
- A leak test must be done after the installation is completed.
- It is a must to do the safety inspection before maintaining or repairing an air conditioner using combustibile refrigerant in order to ensure that the fire risk is reduced to minimum.
- It is necessary to operate the machine under a controlled procedure in order to ensure that any risk arising from the combustibile gas or vapor during the operation is reduced to minimum.
- Requirements for the total weight of filled refrigerant and the area of a room to be equipped with an air conditioner (are shown as in the following Tables GG.1 and GG.2)



# INSTALLATION MANUAL---Important considerations for R32/R290

## The maximum charge and the required minimum floor area

$$m_1 = (4 \text{ m}^3) \times LFL, m_2 = (26 \text{ m}^3) \times LFL, m_3 = (130 \text{ m}^3) \times LFL$$

Where  $LFL$  is the lower flammable limit in  $\text{kg}/\text{m}^3$ , R290  $LFL$  is  $0.038 \text{ kg}/\text{m}^3$ , R32  $LFL$  is  $0.038 \text{ kg}/\text{m}^3$ .

**For the appliances with a charge amount  $m_1 < M = m_2$ :**

The maximum charge in a room shall be in accordance with the following:  $m_{\max} = 2.5 \times (LFL)^{(5/4)} \times h_0 \times A^{1/2}$

The required minimum floor area  $A_{\min}$  to install an appliance with refrigerant charge  $M$  (kg) shall be in accordance with following:  $A_{\min} = (M / (2.5 \times (LFL)^{(5/4)} \times h_0))^2$

Where:

$m_{\max}$  is the allowable maximum charge in a room, in kg;

$M$  is the refrigerant charge amount in appliance, in kg;

$A_{\min}$  is the required minimum room area, in  $\text{m}^2$ ;

$A$  is the room area, in  $\text{m}^2$ ;

$LFL$  is the lower flammable limit, in  $\text{kg}/\text{m}^3$ ;

$h_0$  is the installation height of the appliance, in meters for calculating  $m_{\max}$  or  $A_{\min}$ , 1.8 m for wall mounted;

Table GG.1 - Maximum charge (kg)

Category	LFL ( $\text{kg}/\text{m}^3$ )	$h_0$ (m)	Floor area ( $\text{m}^2$ )						
			4	7	10	15	20	30	50
R290	0.038	0.6	0.05	0.07	0.08	0.1	0.11	0.14	0.18
		1	0.08	0.11	0.13	0.16	0.19	0.2	0.3
		1.8	0.15	0.2	0.24	0.29	0.34	0.41	0.53
		2.2	0.18	0.24	0.29	0.36	0.41	0.51	0.65
R32	0.306	0.6	0.68	0.9	1.08	0.32	1.53	1.87	2.41
		1	1.14	1.51	1.8	2.2	2.54	3.12	4.02
		1.8	2.05	2.71	3.24	3.97	4.58	5.61	7.254
		2.2	2.5	3.31	3.96	4.85	5.6	6.86	8.85

Table GG.2 - Minimum room area ( $\text{m}^2$ )

Category	LFL ( $\text{kg}/\text{m}^3$ )	$h_0$ (m)	Charge amount (M) (kg)						
			Minimum room area ( $\text{m}^2$ )						
R290	0.038		0.152kg	0.228kg	0.304kg	0.456kg	0.608kg	0.76kg	0.988kg
		0.6		82	146	328	584	912	1514
		1		30	53	118	210	328	555
		1.8		9	16	36	65	101	171
		2.2		6	11	24	43	68	115
R32	0.306		1.224kg	1.836kg	2.448kg	3.672kg	4.896kg	6.12kg	7.956kg
		0.6		29	51	116	206	321	543
		1		10	19	42	74	116	196
		1.8		3	6	13	23	36	60
		2.2		2	4	9	15	24	40

# INSTALLATION MANUAL---Important considerations for R32/R290

## ■ Installation Safety Principles

### 1. Site Safety



**Open Flames Prohibited**



**Ventilation Necessary**

### 2. Operation Safety



**Mind Static Electricity**

**Open Flames Prohibited**



**Must wear protective clothing and anti-static gloves**



**Don't use mobile phone**

### 3. Installation Safety

- Refrigerant Leak Detector
- Appropriate Installation Location



**The left picture is the schematic diagram of a refrigerant leak detector.**

Please note that:

1. The installation site should be in a well-ventilated condition.
2. The sites for installing and maintaining an air conditioner using Refrigerant R290 should be free from open fire or welding, smoking, drying oven or any other heat source higher than 370°C which easily produces open fire; the sites for installing and maintaining an air conditioner using Refrigerant R32 should be free from open fire or welding, smoking, drying oven or any other heat source higher than 548°C which easily produces open fire.
3. When installing an air conditioner, it is necessary to take appropriate anti-static measures such as wear anti-static clothing and/or gloves.
4. It is necessary to choose the site convenient for installation or maintenance wherein the air inlets and outlets of the indoor and outdoor units should be not surrounded by obstacles or close to any heat source or combustible and/or explosive environment.
5. If the indoor unit suffers refrigerant leak during the installation, it is necessary to immediately turn off the valve of the outdoor unit and all the personnel should go out till the refrigerant leaks completely for 15 minutes. If the product is damaged, it is a must to carry such damaged product back to the maintenance station and it is prohibited to weld the refrigerant pipe or conduct other operations on the user's site.
6. It is necessary to choose the place where the inlet and outlet air of the indoor unit is even.
7. It is necessary to avoid the places where there are other electrical products, power switch plugs and sockets, kitchen cabinet, bed, sofa and other valuables right under the lines on two sides of the indoor unit.



# INSTALLATION MANUAL---Important considerations for R32/R290

## ■ Special Tools

Tool Name	Requirement(s) for Use
Mini Vacuum Pump	It should be an explosion-proof vacuum pump; can ensure certain precision and its vacuum degree should be lower than 10Pa.
Filling Device	It should be a special explosion-proof filling device; have certain precision and its filling deviation should be less than 5g.
Leak Detector	It should be calibrated regularly; and its annual leak rate should not exceed 10g.
Concentration Detector	A) The maintenance site should be equipped with a fixed-type combustible refrigerant concentration detector and connected to a safeguard alarm system; its error must be not more than 5%. B) The installation site should be equipped with a portable combustible refrigerant concentration detector which can realize two-level audible and visual alarm; its error must be not more than 10%. C) The concentration detectors should be calibrated regularly. D) It is necessary to check and confirm the functions before using the concentration detectors.
Pressure Gauge	A) The pressure gauges should be calibrated regularly. B) The pressure gauge used for Refrigerant 22 can be used for Refrigerants R290 and R161; the pressure gauge used for R410A can be used for Refrigerant 32.
Fire Extinguisher	It is necessary to carry fire extinguisher(s) when installing and maintaining an air conditioner. On the maintenance site, there should be two or more kinds of dry powder, carbon dioxide and foam fire extinguishers and that such fire extinguishers should be placed at stipulated positions, with eye-catching labels and in handy places.

# INSTALLATION MANUAL---Selecting the Installation Place

## INDOOR UNIT

- Install the indoor unit on a strong wall that is not subject to vibrations.
- The in let and outlet ports should not be obstructed:the air should be able to blow all over the room.
- Do not install the unit near a source of heat , steam, or flammable gas.
- Do not install the unit where it will be exposed to direct sunlight.
- Select a site where the condensed water can be easily drained out, and where it is easily connected to outdoor unit.
- Check the machine operation regularly and reserve the necessary spaces as shown in the picture.
- Select a place where the filter can be easily taken out.

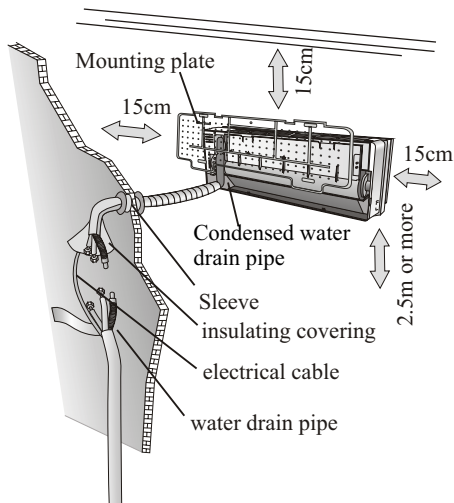

## OUTDOOR UNIT

- Do not install the outdoor unit near sources of heat, steam or flammable gas.
- Do not install the unit in too windy or dusty places.
- Do not install the unit where people often pass. Select a place where the air discharge and operating sound will not disturb the neighbours.
- Avoid installing the unit where it will be exposed to direct sunlight ( other wise use a protection , if necessary, that should not interfere with the air flow).
- Reserve the spaces as shown in the picture for the air to circulate freely.
- Install the outdoor unit in a safe and solid place.
- If the outdoor unit is subject to vibration, place rubber gaskets onto the feet of the unit..

minimum space to be reserved (mm) showing in the picture

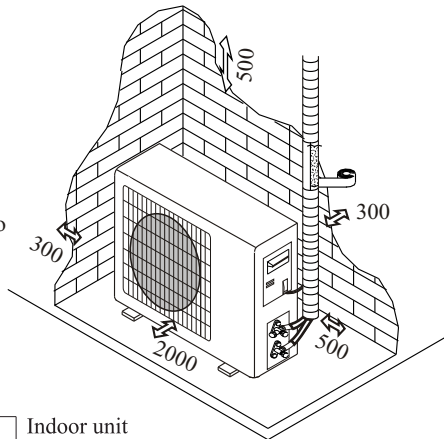

### Installation Diagram

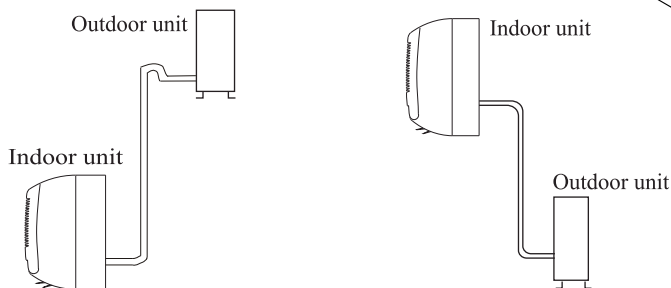

The purchaser must ensure that the person and/or company who is to install, maintain or repair this air conditioner has qualifications and experience in refrigerant products.

# INSTALLATION MANUAL---Installation of the Indoor unit

Before starting installation, decide on the position of the indoor and outdoor units, taking into account the minimum space reserved around the units

- ⚠ Do not install your air conditioner in a wet room such as a bathroom or laundry etc
- ⚠ The installation site should be 250cm or more above the floor.

**To install, proceed as follows:**

## Installation of the mounting plate

1. Always mount the rear panel horizontally and vertically
2. Drill 32 mm deep holes in the wall to fix the plate;
3. Insert the plastic anchors into the hole;
4. Fix the rear panel on the wall with provided tapping screws
5. Be sure that the rear panel has been fixed firmly enough to withstand the weight.

*Note : The shape of the mounting plate may be different from the one above, but installation method is similar .*

## Drilling a hole in the wall for the piping

1. Make the piping hole ( $\Phi 65$ ) in the wall at a slight downward slant to the outdoor side.
2. Insert the piping-hole sleeve into the hole to prevent the connection piping and wiring from being damaged when passing through the hole.

- ⚠ The hole must slope downwards towards the exterior

*Note : Keep the drain pipe down towards the direction of the wall hole, otherwise leakage may occur.*

## Electrical connections---Indoor unit

1. Open the front panel.
2. Take off the cover as indicated in the picture ( by removing a screw or breaking the hooks).
3. For the electrical connections, see the circuit diagram on the right part of the unit under the front panel.
4. Connect the cable wires to the screw terminals by following the numbering ,Use wire size suitable to the electric power input (see name plate on the unit) and according to all current national safety code requirements.

- ⚠ The cable connecting the outdoor and indoor units must be suitable for outdoor use.

- ⚠ The plug must be accessible also after the appliance has been installed so that it can be pulled out if necessary.

- ⚠ An efficient earth connection must be ensured.

- ⚠ If the power cable is damaged, it must be replaced by an authorised Service Centre.

*Note: Optional the wires can be connected to the main PCB of indoor unit by manufacturer according to the model without terminal block.*

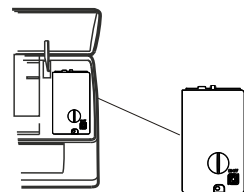
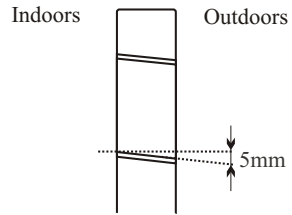
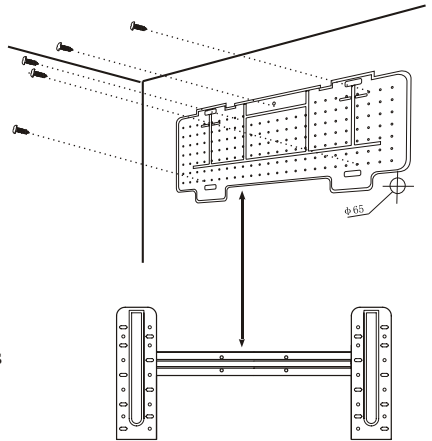

# INSTALLATION MANUAL---Installation of the Indoor unit

## Refrigerant piping connection

The piping can be run in the 3 directions indicated by numbers in the picture . When the piping is run in direction 1 or 3, cut a notch along the groove on the side of the indoor unit with a cutter.

Run the piping in the direction of the wall hole and bind the copper pipes , the drain pipe and the power cables together with the tape with the drain pipe at the bottom, so that water can flow freely.

- Do not remove the cap from the pipe until connecting it, to avoid dampness or dirt from entering.
- If the pipe is bent or pulled too often , it will become stiff . Do not bend the pipe more than three times at one point.
- When extending the rolled pipe, straighten the pipe by unwinding the rolled pipe, straighten the pipe by unwinding it gently as shown in the picture.

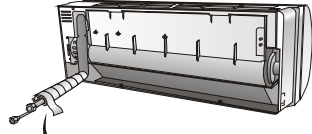
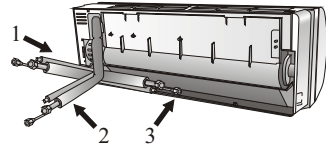

Shape the connection pipe

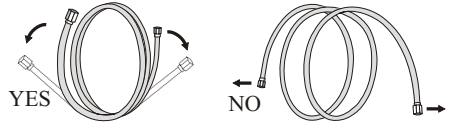

Extending the rolled pipe

## Connections to the indoor unit

1. Remove the indoor unit pipe cap (check that there is no debris inside).
2. Insert the flare nut and create a flange at the extreme end of the connection pipe.
3. Tighten the connections by using two wrenches working in opposite directions.
4. For R32/R290 refrigerants, mechanical connectors should be outdoors.



Indoors      Outdoors

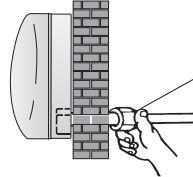

The connectors should be outdoors

## Indoor unit condensed water drainage

The indoor unit condensed water drainage is fundamental for the success of the installation.

1. Place the drain hose below the piping, taking care not to create siphons.
2. The drain hose must slant downwards to aid drainage.
3. Do not bend the drain hose or leave it protruding or twisted and do not put the end of it in water . If an extension is connected to the drain hose , ensure that it is lagged when it passes into the indoor unit.
4. If the piping is installed to the right, the pipes , power cable and drain hose must be lagged and secured onto the rear of the unit with a pipe connection.
  - 1) Insert the pipe connection into the relative slot.
  - 2) Press to join the pipe connection to the base.

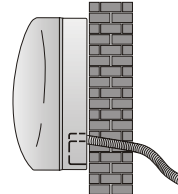

YES

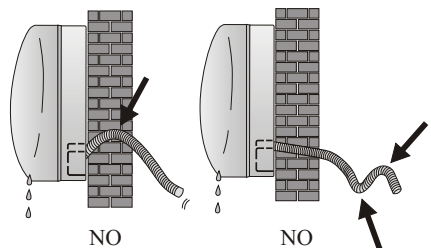

NO

NO

# INSTALLATION MANUAL---Installation of the Indoor unit

## INSTALLATION OF THE INDOOR UNIT

After having connected the pipe according to the instructions, install the connection cables. Now install the drain pipe. After connection, lag the pipe, cables and drain pipe with the insulating material.

1. Arrange the pipes ,cables and drain hose well.
2. Lag the pipe joints with insulating material , securing it with vinyl tape.
3. Run the bound pipe , Cables and drain pipe through the wall hole and mount the indoor unit onto the upper part of the mounting plate securely.
4. Press and push the lower part of the indoor unit tightly against the mounting plate

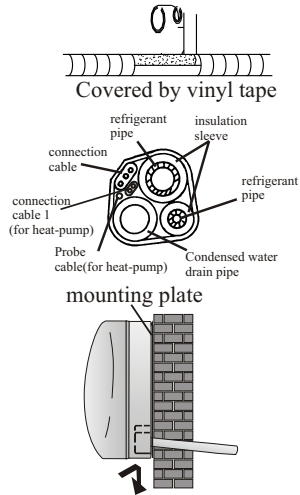

**Sometimes, if the refrigerant piping is already embedded in the wall, or if you want to connecting the piping and wiring on the wall, do as below:**

1. Grab both ends of the bottom plate, apply a little outward force to take off the bottom plate.
2. Hook the top of the indoor unit on the mounting plate without piping and wiring.
3. Lift the indoor unit opposite the wall, unfold the bracket on the mounting plate, and use this bracket to prop up the indoor unit, there will be a big space for operation.
4. Do the refrigerant piping, wiring, connect drainage hose, and wrap them as **Step 4 to 7**.
5. Replace the bracket of mounting plate.
6. Push down the bottom of indoor unit to let the snaps onto the bottom hooks of the mounting plate, and make sure it is hooked firmly.
7. Replace the bottom plate of the indoor unit.

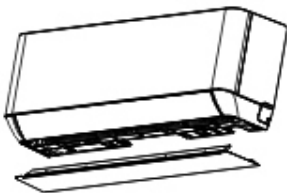

Take off the bottom plate

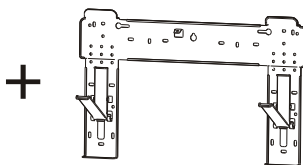

Unfold the bracket on the mounting plate

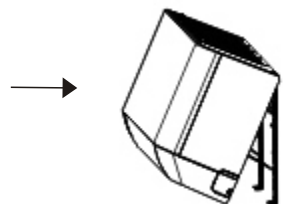

# INSTALLATION MANUAL---Installation of the outdoor unit

- The outdoor unit should be installed on a solid wall and fastened securely.
- The following procedure must be observed before connecting the pipes and connecting cables : decide which is the best position on the wall and leave enough space to be able to carry out maintenance easily.
- Fasten the support to the wall using screw anchors which are particularly suited to the type of wall;
- Use a larger quantity of screw anchors than normally required for the weight they have to bear to avoid vibration during operation and remain fastened in the same position for years without the screws becoming loose.
- The unit must be installed following the national regulations.
- The outdoor unit should be installed on a solid wall and fastened securely, or on the ground on a flat/level surface like a concrete slab. The bolt size is M8\*80mm.

## Outdoor unit condensed water drainage (only for heat pump models)

The condensed water and the ice formed in the outdoor unit during heating operation can be drained away through the drain pipe

1. Fasten the drain port in the 25mm hole placed in the part of the unit as shown in the picture.
  2. Connect the drain port and the drain pipe.
- Pay attention that water is drained in a suitable place.

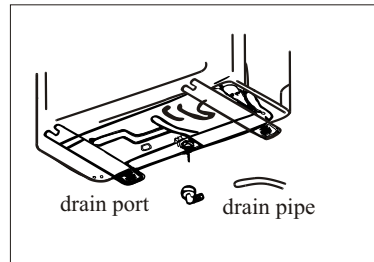

# INSTALLATION MANUAL---Installation of the outdoor unit

## ELECTRICAL CONNECTIONS

1. Remove the handle on the right side plate of outdoor unit.
2. Connect the power connection cord to the terminal board.  
Wiring should fit that of indoor unit.
3. Fix the power connection cord with wire clamp.
4. Confirm if the wire has been fixed properly.
5. An efficient earth connection must be ensured.
6. Recover the handle.
7. The appliance must be fitted with means for disconnection from the supply mains having a contact separation in all poles that provide full disconnection under over voltage category III conditions, and these means must be incorporated in the fixed wiring in accordance with the wiring rules.

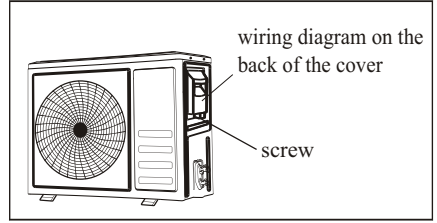

## CONNECTING THE PIPES

Screw the flare nuts to the outdoor unit coupling with the same tightening procedures described for the indoor unit.

To avoid leakage, pay attention to the following points:

1. Tighten the flare nuts using two wrenches. Pay attention not to damage the pipes.
2. If the tightening torque is not sufficient, there will probably be some leakage. With excessive tightening torque there will also be some leakage, as the flange could be damaged.
3. The surest system consists in tightening the connection by using a fix wrench and a torque wrench as below:

PIPE Size	Newton meter [N x m]	Pound-force foot (1bf-ft)	Kilogram-force meter (kgf-m)
1/4 " (φ 6.35)	18 - 20	24.4 - 27.1	2.4 - 2.7
3/8 " (φ 9.52)	30 - 35	40.6 - 47.4	4.1 - 4.8
1/2 " (φ 12)	45 - 50	61.0 - 67.7	6.2 - 6.9
5/8 " (φ 15.88)	60 - 65	81.3 - 88.1	8.2 - 8.9

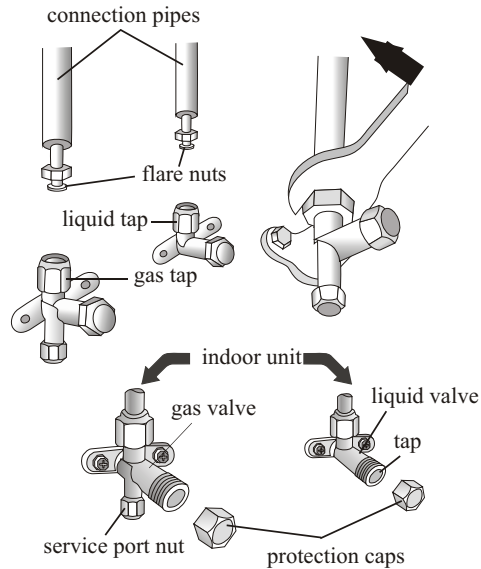

# INSTALLATION MANUAL---Installation of the outdoor unit

## Air Vacuumizing

1. Use a spanner to take down the protective caps from the service port, low pressure valve and high pressure valve of the outdoor unit.
2. Connect the pressure hose of manifold gauge to the service port on the outdoor unit low pressure valve.
3. Connect the charge hose from the manifold gauge to the vacuum pump.
4. Open the low pressure valve of the manifold gauge and close the high pressure valve.
5. Turn on the vacuum pump to vacuumize the system.
6. The vacuuming times should not be less than 15 minutes, or make sure the compound gauge indicates  $-0.1 \text{ MPa}$  ( $-76 \text{ cmHg}$ )
7. Close the low pressure valve of the manifold gauge and turn off the vacuum.
8. Hold the pressure for 5 minutes, make sure that the rebound of compound gauge pointer does not exceed  $0.005 \text{ Mpa}$ .
9. Turn the low pressure valve counterclockwise for  $1/4$  turn with hexagonal wrench to let a little refrigerant fill in the system, and close the low pressure valve after 5 seconds and quickly remove the pressure hose.
10. Check all indoor and outdoor joints for leakage with soapy water or leak detector.
11. Fully open the low pressure valve and high pressure valve of the outdoor unit with hexagonal wrench.
12. Replace the protective caps of the service port, low pressure valve and high pressure valve of the outdoor unit.
13. Replace the valve cover.

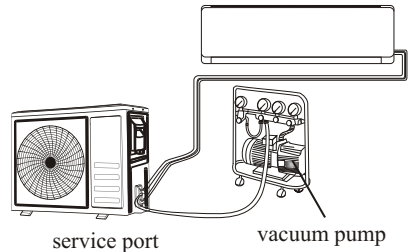

## Refrigerant Pressure Inspection

Air-returning Low-pressure Range of Refrigerant R290:  $0.4\text{-}0.6 \text{ Mpa}$ ; Air-exhausting High-pressure Range:  $1.5\text{-}2.0 \text{ Mpa}$ ;  
Air-returning Low-pressure Range of Refrigerant R32:  $0.8\text{-}1.2 \text{ Mpa}$ ; Air-exhausting High-pressure Range:  $3.2\text{-}3.7 \text{ Mpa}$ ;  
It means that the refrigerating system or refrigerant of an air conditioner is abnormal if the air-exhausting and air-returning pressure ranges of the detected compressor exceed the normal ranges to a large extent.

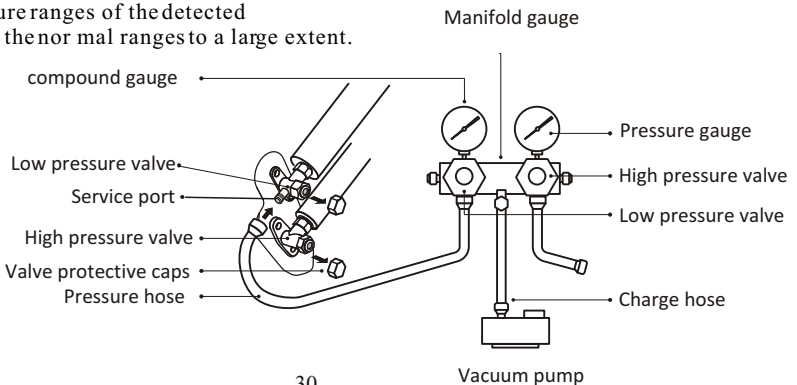



# INSTALLATION MANUAL---Installation of the outdoor unit

## BLEEDING

The air and humidity left inside the refrigerant circulation can cause compressor malfunction. After having connected the indoor and outdoor units, bleed the air and humidity from the refrigerant circulation using a vacuum pump.

- (1) Unscrew and remove the caps from the 2 - way and 3-way valves.
- (2) Unscrew and remove the cap from the service port.
- (3) Connect the vacuum pump hose to the service port.
- (4) Operate the vacuum pump for 10 - 15 minutes until an absolute vacuum of 10 mm Hg has been reached.
- (5) With the vacuum pump still in operation, close the low - pressure knob on the vacuum pump coupling. Stop the vacuum pump.
- (6) Open the 2 - way valve by 1/4 turn and then close it after 10 seconds. Check all the joints for leaks using liquid soap or an electronic leak device.
- (7) Turn the body of the 2-way and 3-way valves. Disconnect the vacuum pump hose.
- (8) Replace and tighten all the caps on the valves.

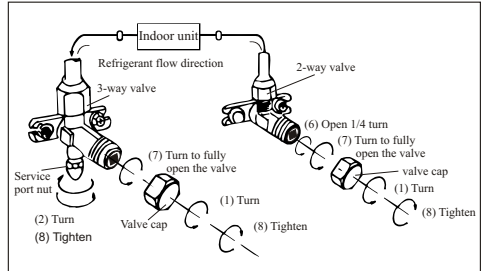
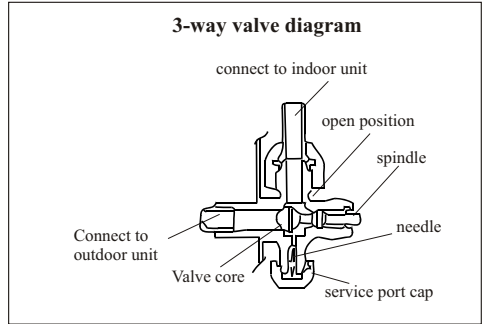

## INSTALLATION MANUAL--- operation test

1. Wind insulating covering around the joints of the indoor unit and fix it with insulating tape.
2. Fix the exceeding part of the signal cable to the piping or to the outdoor unit.
3. Fix the piping to the wall ( after having coated it with insulating tape) using clamps or insert them into plastic slots.
4. Seal the hole in the wall through which the piping is passed so that no air or water can fill.

### Indoor unit test

- Do the ON/OFF and FAN operate normally?
- Does the MODE operate normally?
- Do the set point and TIMER function properly?
- Does each lamp light normally?
- Do the flap for air flow direction operate normally?
- Is the condensed water drained regularly?

### Outdoor unit test

- Is there any abnormal noise or vibration during operation?
- Could the noise, the air flow or the condensed water drainage disturb the neighbours?
- Is there any coolant leakage?

*Note: the electronic controller allows the compressor to start only three minutes after voltage has reached the system.*

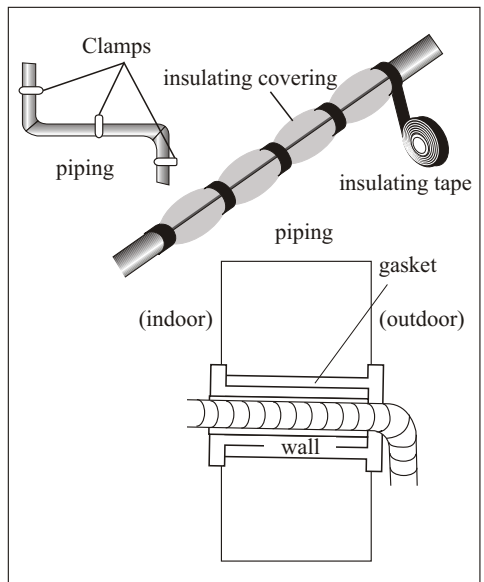

# INSTALLATION MANUAL---Information for the installer

## Pipe length and Additional refrigerant

Inverter Models capacity (Btu/h)	9k-12k		18k-36K	
Lenght of pipe with standard charge	5m	5m	5m	5m
Maximum distance between indoor and outdoor unit	15m	15m	25m	25m
Additional refrigerant charge	20g/m	15g/m	30g/m	25g/m
Max. diff. in level between indoor and outdoor unit	10m	10m	10m	10m
Type of refrigerant	R22/R410A	R32	R22/R410A	R32

ON-OFF Models capacity (Btu/h)	9k-12k		18k-36K	
Lenght of pipe with standard charge	5m	5m	5m	5m
Maximum distance between indoor and outdoor unit	15m	15m	15m	15m
Additional refrigerant charge	20g/m	15g/m	30g/m	25g/m
Max. diff. in level between indoor and outdoor unit	5m	5m	5m	5m
Type of refrigerant	R22/R410A	R32	R22/R410A	R32

## Dedicated Distribution Device and Wire for Air Conditioner

Min. Circuit Ampacity of Air Conditioner (A)	Minimum Wire Cross-sectional Area(mm <sup>2</sup> )	Specification of Socket or Switch (A)	Fuse Specification (A)
≤8	0.75	15	15
>8 and ≤10	1.0	15	15
>10 and ≤15	1.5	20	25
>15 and ≤24	2.5	25	40
>24 and ≤28	4.0	35	45
>28 and ≤32	6.0	40	55

### Note:

This table is only for reference, the installation shall meet the requirements of local laws and regulations.

# INSTALLATION MANUAL---Information for the installer

## WIRING DIAGRAM

For different models, the wiring diagram may be different. Please refer to the wiring diagrams pasted on the indoor unit and outdoor unit respectively.

On indoor unit, the wiring diagram is pasted under the front panel;

On outdoor unit, the wiring diagram is pasted on the backside of the outdoor handle cover.

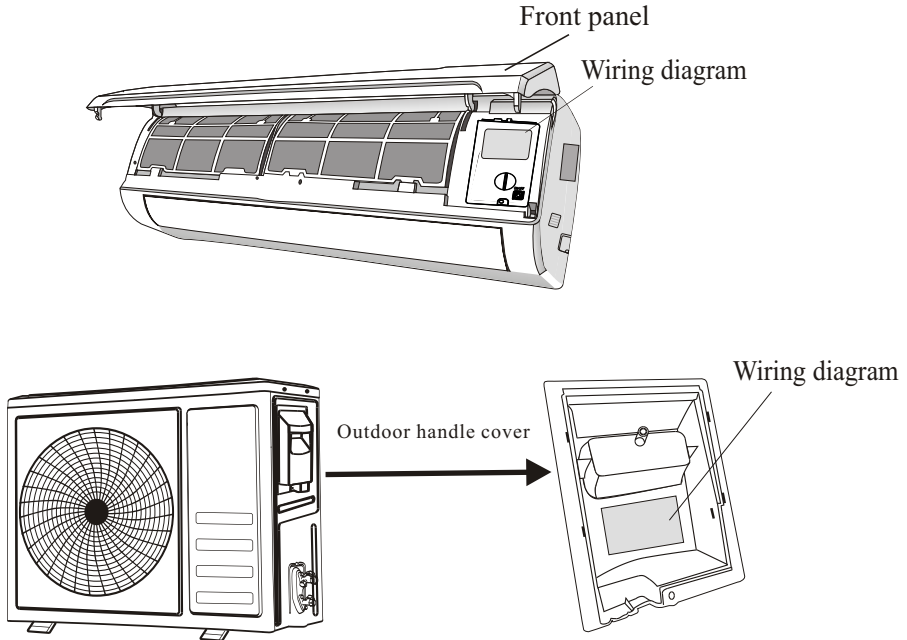

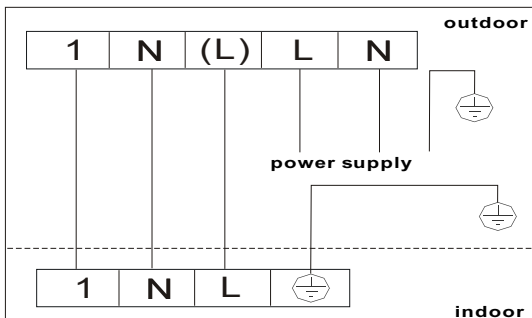

Wiring example:





*Note: For some models the wires has been connected to the main PCB of indoor unit by manufacturer without terminal block.*

# INSTALLATION MANUAL---Information for the installer

## CABLE WIRES SPECIFICATION

INVERTER TYPE MODEL capacity (Btu/h)		9k	12k	18k	24k	28k
		sectional area				
Power supply cable	N	1.5mm <sup>2</sup>	1.5mm <sup>2</sup>	2.5mm <sup>2</sup>	2.5mm <sup>2</sup>	2.5mm <sup>2</sup>
	L	1.5mm <sup>2</sup>	1.5mm <sup>2</sup>	2.5mm <sup>2</sup>	2.5mm <sup>2</sup>	2.5mm <sup>2</sup>
		1.5mm <sup>2</sup>	1.5mm <sup>2</sup>	2.5mm <sup>2</sup>	2.5mm <sup>2</sup>	2.5mm <sup>2</sup>
Connection supply cable	N	0.75mm <sup>2</sup>	0.75mm <sup>2</sup>	0.75mm <sup>2</sup>	0.75mm <sup>2</sup>	1.5mm <sup>2</sup>
	L	0.75mm <sup>2</sup>	0.75mm <sup>2</sup>	0.75mm <sup>2</sup>	0.75mm <sup>2</sup>	1.5mm <sup>2</sup>
	1	0.75mm <sup>2</sup>	0.75mm <sup>2</sup>	0.75mm <sup>2</sup>	0.75mm <sup>2</sup>	1.5mm <sup>2</sup>
		0.75mm <sup>2</sup>	0.75mm <sup>2</sup>	0.75mm <sup>2</sup>	0.75mm <sup>2</sup>	1.5mm <sup>2</sup>

ON/OFF TYPE MODEL capacity (Btu/h)		5k	7k	9k	12k	15k/18k	22k/24k	28~36k
		sectional area						
Power supply cable	N	1.0mm <sup>2</sup>	1.0mm <sup>2</sup>	1.0mm <sup>2</sup>	1.0mm <sup>2</sup>	1.5mm <sup>2</sup>	2.5mm <sup>2</sup>	4.0mm <sup>2</sup>
	L	1.0mm <sup>2</sup>	1.0mm <sup>2</sup>	1.0mm <sup>2</sup>	1.0mm <sup>2</sup>	1.5mm <sup>2</sup>	2.5mm <sup>2</sup>	4.0mm <sup>2</sup>
		1.0mm <sup>2</sup>	1.0mm <sup>2</sup>	1.0mm <sup>2</sup>	1.0mm <sup>2</sup>	1.5mm <sup>2</sup>	2.5mm <sup>2</sup>	4.0mm <sup>2</sup>
Connection supply cable	N	1.0mm <sup>2</sup>	1.0mm <sup>2</sup>	1.0mm <sup>2</sup>	1.0mm <sup>2</sup>	1.5mm <sup>2</sup>	0.75mm <sup>2</sup>	0.75mm <sup>2</sup>
	(L)	1.0mm <sup>2</sup>	1.0mm <sup>2</sup>	1.0mm <sup>2</sup>	1.0mm <sup>2</sup>	1.5mm <sup>2</sup>	0.75mm <sup>2</sup>	0.75mm <sup>2</sup>
	1	1.0mm <sup>2</sup>	1.0mm <sup>2</sup>	1.0mm <sup>2</sup>	1.0mm <sup>2</sup>	1.5mm <sup>2</sup>	0.75mm <sup>2</sup>	0.75mm <sup>2</sup>
	2	0.75mm <sup>2</sup>	0.75mm <sup>2</sup>	0.75mm <sup>2</sup>	0.75mm <sup>2</sup>	0.75mm <sup>2</sup>	0.75mm <sup>2</sup>	0.75mm <sup>2</sup>
	3	0.75mm <sup>2</sup>	0.75mm <sup>2</sup>	0.75mm <sup>2</sup>	0.75mm <sup>2</sup>	0.75mm <sup>2</sup>	0.75mm <sup>2</sup>	0.75mm <sup>2</sup>
		0.75mm <sup>2</sup>	0.75mm <sup>2</sup>	0.75mm <sup>2</sup>	0.75mm <sup>2</sup>	0.75mm <sup>2</sup>	0.75mm <sup>2</sup>	0.75mm <sup>2</sup>

220V Air conditioner (7k~30k) indoor unit fuse : 50T, 3.15A

110V Air conditioner (7k~12k) indoor unit fuse : 50T, 3.15A

125V Air conditioner (7k~12k) indoor unit fuse : 61T, 15A

# MAINTENANCE

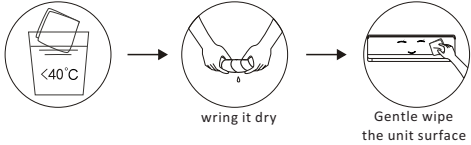
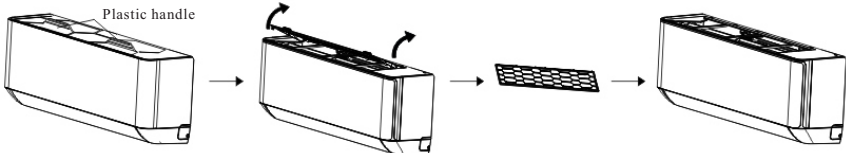
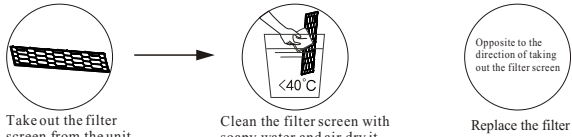
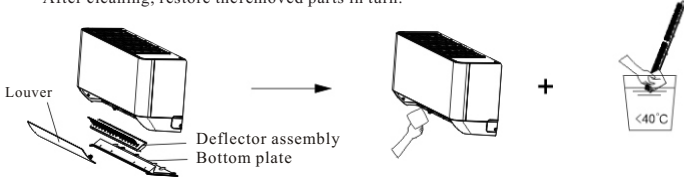
<p>Warning</p> 	<ul style="list-style-type: none"> <li>• When cleaning, you must shut down the machine and cut off the power supply for more than 5 minutes.</li> <li>• Under no circumstances should the air conditioner be flushed with water.</li> <li>• Volatile liquid (e.g. thinner or gasoline) will damage the air conditioner, so only use soft dry cloth or wet cloth dipped with neutral detergent to clean the air conditioner.</li> <li>• Pay attention to cleaning the filter screen regularly to avoid dust covering which will affect the filter screen effect. When the operating environment is dusty, the cleaning frequency should be increased appropriately.</li> <li>• After removing the filter screen, do not touch the fins of the indoor unit to avoid scratching.</li> </ul>
<p>Clean the unit</p>	 <p>Tip: Wipe frequently to keep air conditioner clean and good appearance .</p>
<p>Disassembly and assembly of filter screen</p>	<ul style="list-style-type: none"> <li>• Grasp the raised plastic handle on the filter screen by hand, and then pull the filter screen out in the direction deviating from the unit, so that the upper edge of the filter screen is separated from the unit. The filter can be removed by lifting the filter upwards.</li> <li>• When installing the filter screen, first insert the lower end of the filter screen into the corresponding position of the unit, and then squeeze the upper end of the filter screen into the corresponding buckling position of the unit body.</li> </ul> 
<p>Clean the filter screen</p>	 <p>Tip: When you find accumulated dust in the filter screen, please clean the filter screen in time to ensure the clean, healthy and efficient operation inside the air conditioner.</p>
<p>Cleaning of inner air duct</p>	<ul style="list-style-type: none"> <li>• First, loosen the knob in the middle of louver and bend the louver outwards to take it out.</li> <li>• Then, grasp both sides of bottom plate push downwards to take down the bottom plate.</li> <li>• Finally, loosen the buckle of deflector assembly with your thumb and take it out.</li> <li>• Wipe the air duct and fan assembly with a clean and wrung wet rag.</li> <li>• Clean the removed parts with soapy water and air dry it.</li> <li>• After cleaning, restore the removed parts in turn.</li> </ul> 
<p>Service and maintenance</p>	<ul style="list-style-type: none"> <li>• When the air conditioner is not in use for a long time, do the following work: Take out the batteries of the remote controller and disconnect the power supply of the air conditioner.</li> <li>• When starting to use after long-term shutdown:             <ol style="list-style-type: none"> <li>1. Clean the unit and filter screen;</li> <li>2. Check whether there are obstacles at their inlet and outlet of indoor and outdoor units;</li> <li>3. Check whether the drain pipe is unobstructed;</li> </ol>             Install the batteries of the remote controller and check whether the power is on.           </li> </ul>

# TROUBLESHOOTING

MALFUNCTION	POSSIBLE CAUSES
The appliance does not operate	Power failure/plug pulled out.
	Damaged indoor/outdoor unit fan motor.
	Faulty compressor thermomagnetic circuit breaker.
	Faulty protective device or fuses.
	Loose connections or plug pulled out.
	It sometimes stops operating to protect the appliance.
	Voltage higher or lower than the voltage range.
	Active TIMER-ON function.
Damaged electronic control board.	
Strange odor	Dirty air filter.
Noise of running water	Back flow of liquid in the refrigerant circulation.
A fine mist comes from the air outlet	This occurs when the air in the room becomes very cold, for example in the “COOLING” or “DEHUMIDIFYING/DRY” modes.
A strange noise can be heard	This noise is made by the expansion or contraction of the front panel due to variations in temperature and does not indicate a problem.
Insufficient airflow, either hot or cold	Unsuitable temperature setting.
	Obstructed air conditioner intakes and outlets.
	Dirty air filter.
	Fan speed set at minimum.
	Other sources of heat in the room.
No refrigerant.	
The appliance does not respond to commands	Remote control is not close enough to indoor unit.
	The batteries of remote control need to be replaced.
	Obstacles between remote control and signal receiver in indoor unit.
The display is off	Active LIGHT function.
	Power failure.
Switch off the air conditioner immediately and cut off the power supply in the event of:	Strange noises during operation.
	Faulty electronic control board.
	Faulty fuses or switches.
	Spraying water or objects inside the appliance.
	Overheated cables or plugs.
	Very strong smells coming from the appliance.

## ERROR SIGNALS ON THE DISPLAY

In case of error, the display on the indoor unit shown the following error codes:

Display	Description of the trouble	Display	Description of the trouble
<i>E1</i>	Indoor temperature sensor fault	<i>E8</i>	Outdoor discharge temperature sensor fault
<i>E2</i>	Indoor pipe temperature sensor fault	<i>E9</i>	Outdoor IPM module fault
<i>E3</i>	Outdoor pipe temperature sensor fault	<i>Ea</i>	Outdoor current detect fault
<i>E4</i>	Refrigerant system leakage or fault	<i>Ee</i>	Outdoor PCB EEPROM fault
<i>E5</i>	Malfunction of indoor fan motor	<i>Ef</i>	Outdoor fan motor fault
<i>E7</i>	Outdoor air temperature sensor fault	<i>EH</i>	Outdoor suction temperature sensor fault



Like us on Facebook

**TCL Electronics Australia Pty Ltd**

ABN 83 111 032 896

Telephone: 1300 738 149

[service.au@tcl.com](mailto:service.au@tcl.com)

[www.tcl.com/au](http://www.tcl.com/au)